

thermo scientific

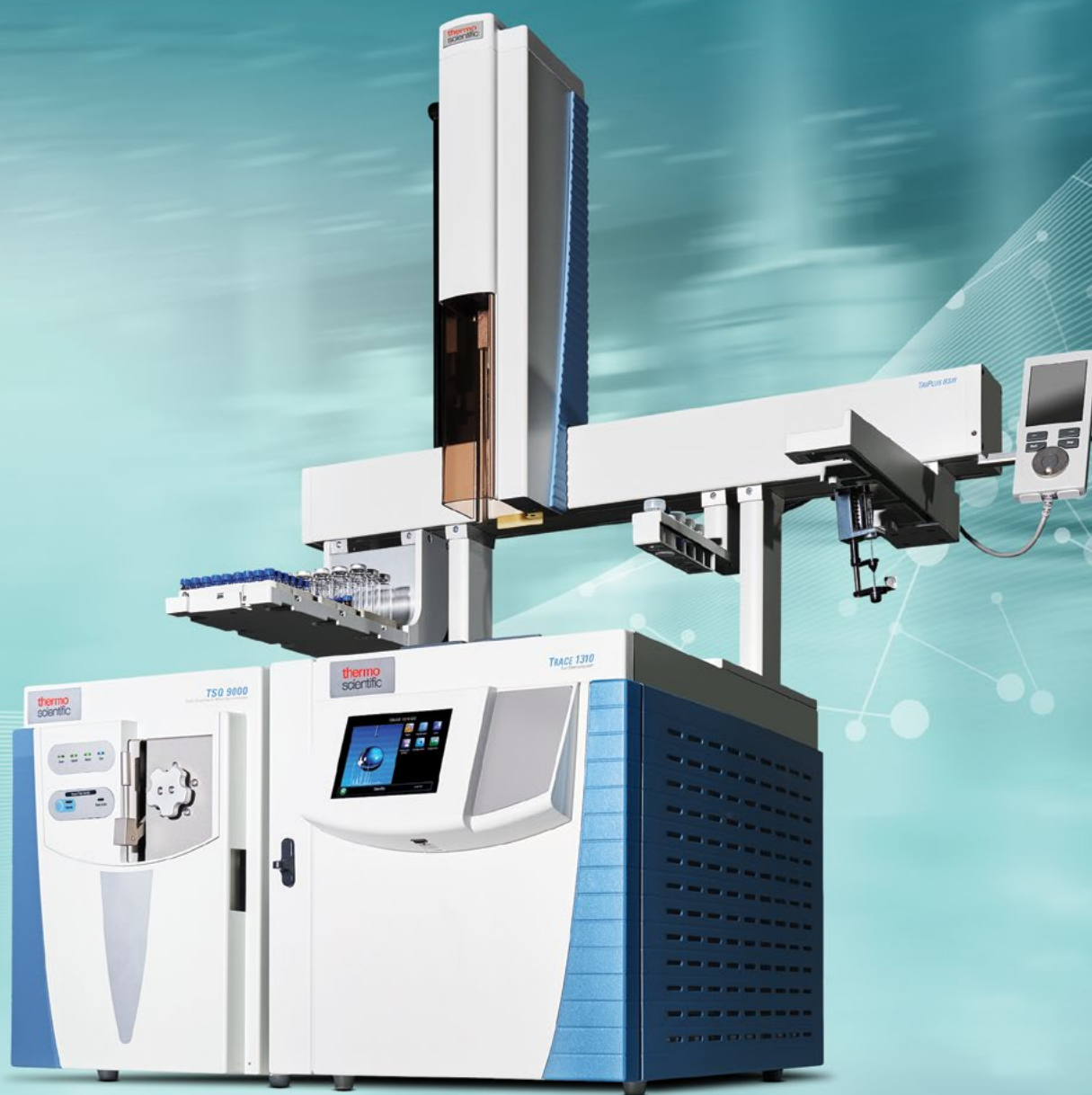

NOW YOU'RE
UNSTOPPABLE

Thermo Scientific TSQ 9000
Triple Quadrupole GC-MS/MS System

ThermoFisher
SCIENTIFIC

Unstoppable GC-MS/MS Analysis

Routine laboratories working in food, environmental and forensic/toxicology analysis face a dynamic environment of changing regulatory requirements, lower detection levels, more compounds, less time, lower margins and increased competition. In short, they need their analytical systems to be unstoppable.

The Thermo Scientific™ TSQ™ 9000 GC-MS/MS system is a GC triple quadrupole platform designed to revolutionize laboratory productivity by delivering unprecedented levels of performance, ease-of-use and uptime, with the ultimate goal of facilitating the reduction of cost-per-sample in the high-throughput environment.

Unlike other systems, the TSQ 9000 GC-MS/MS system offers laboratories the opportunity to select best-in-class SRM performance, even for high capacity methods, whilst still benefiting from increased analytical robustness.

The TSQ 9000 GC-MS/MS system is uniquely placed to offer truly scalable performance that addresses increasingly challenging regulatory requirements, as well as providing effective ease-of-use tools to deliver consistent, class leading results, by both experienced and newer users.

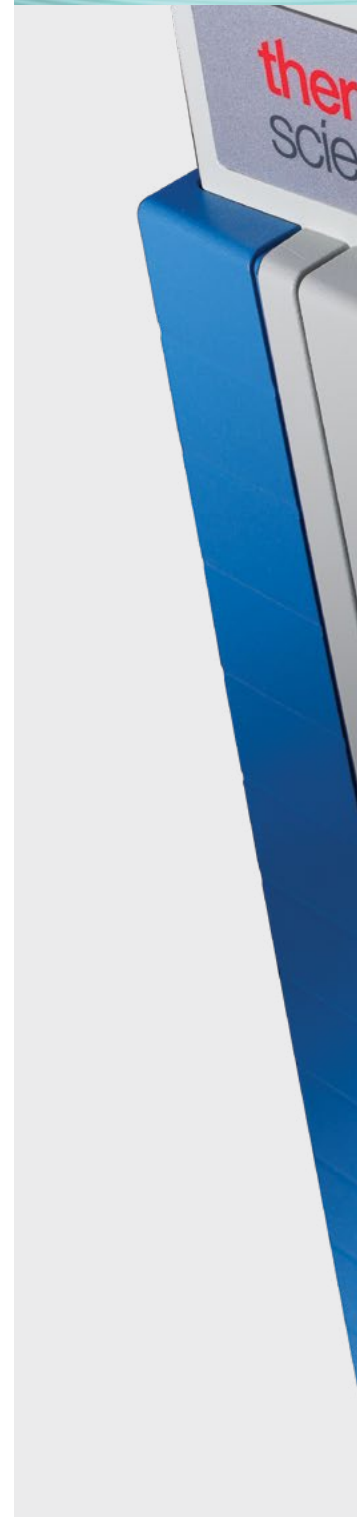



Food Safety



Environmental Contaminants



Forensic/
Toxicology



Unstoppable sensitivity

Unstoppable sensitivity means incredible sensitivity delivered robustly, in routine. The TSQ 9000 GC-MS/MS system can deliver high sensitivity for more routine analysis through the renowned, highly robust Thermo Scientific™ ExtractaBrite™ ion source technology. For the highest level of sensitivity, the ultra-robust Thermo Scientific™ Advanced Electron Ionization (AEI) source can be configured to reach into the attogram range of instrument detection limits, unlocking new possibilities for your laboratory.

ExtractaBrite Ion Source

Robust, rugged electron ionization (EI) and chemical ionization (CI) performance – proven in routine applications in the Thermo Scientific™ ISQ™ GC-MS systems and TSQ™ 8000 GC-MS/MS

systems. Fully removable without breaking vacuum, when used with the vacuum probe interlock (VPI) technology, for maintenance or switching to chemical ionization (CI).

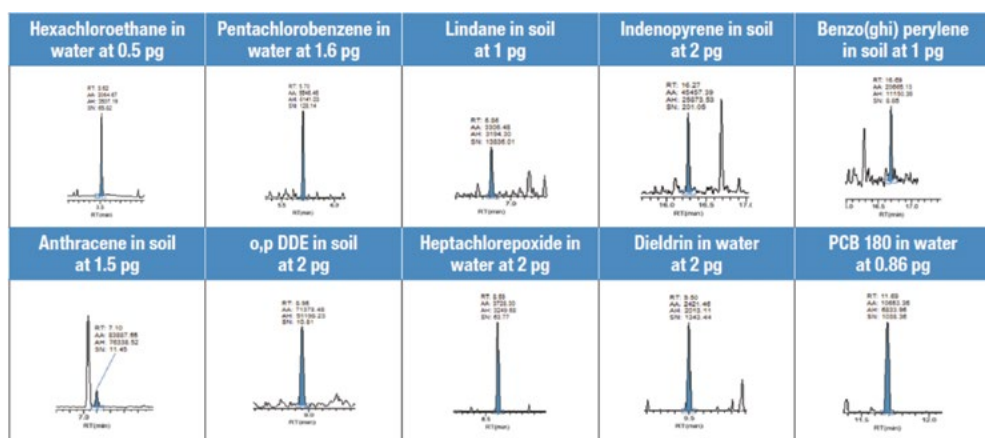

On column concentrations measured in various environmental matrices using SRM mode with ExtractaBrite ion source.

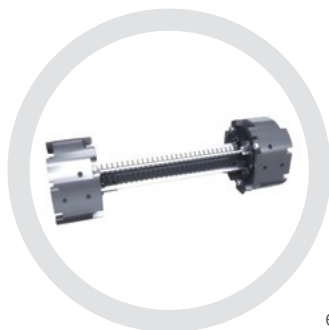

EvoCell

Enhanced velocity optics driving EvoCell collision cell technology provides high SRM transition speeds up to 800 SRMs/s, with better precision and sensitivity for even the most complex methods. This high performance technology allows for more opportunities for efficient and effective workflows in the high throughput laboratory.

Increased method scope

- Single acquisition method for a wider range of compounds and matrices

Increased throughput

- Compress GC methods for faster runtimes

Increase resistance to matrix effects

- Reduced interference risk with more transitions
- Reduced peak losses related to RT shift with wider acquisition windows

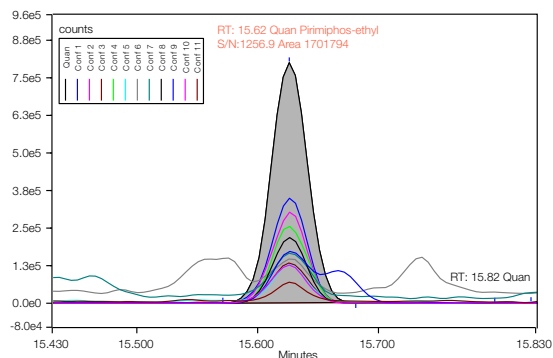

Pirimiphos-ethyl 10 ppb in apple QuEChERS extract– 1µL acetonitrile injected with 11 SRM transitions acquired and 64 simultaneous transitions at peak apex.

Advanced Electron Ionization (AEI) Source

A new ultra-robust, ultimate sensitivity electron ionization source is available in a dedicated TSQ 9000 GC/MS-MS system configuration to tackle the most challenging of applications, as well as offering the opportunity to relieve matrix pressure on the analytical system, through the reduction of concentration steps in sample preparation.

The AEI source provides a highly efficient ionization of analytes and a more tightly focused ion beam, driving down instrument detection limits into the attogram range.

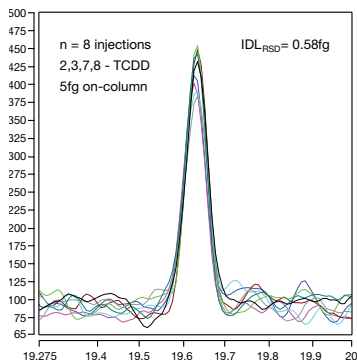

Instrument detection limits into the attogram range for challenging applications such as dioxins analysis.*

Congener	Concentration (pg/ul)		TSQ 9000 LOQ - PE	EU Criteria Compliant?
Native PCDDs	EN-1948 CSL	EN-1948 CS1/4		
2378-TCDD	0.04	0.01	0.02	✓
12378-PeCDD	0.08	0.02	0.04	✓
123478-HxCDD	0.08	0.02	0.08	✓
123678-HxCDD	0.08	0.02	0.08	✓
123789-HxCDD	0.08	0.02	0.08	✓
1234678-HpCDD	0.16	0.04	0.08	✓
OCDD	0.16	0.04	0.32	✓
Native PCDFs	EN-1948 CSL	EN-1948 CS1/4	TSQ 9000 LOQ	
2378-TCDF	0.04	0.01	0.02	✓
12378-PeCDF	0.08	0.02	0.04	✓
23478-PeCDF	0.08	0.02	0.04	✓
123478-HxCDF	0.08	0.02	0.04	✓
123678-HxCDF	0.08	0.02	0.04	✓
234678-HxCDF	0.08	0.02	0.04	✓
123789-HxCDF	0.08	0.02	0.04	✓
1234789-HpCDF	0.16	0.04	0.08	✓
1234789-HpCDF	0.16	0.04	0.08	✓
OCDF	0.16	0.04	0.32	✓

LOQ (shown in bold) was set at the lowest calibration curve point which demonstrated ion ratios (IR) and response factors (RF) repeatedly within permitted EU tolerances (IR $\pm 15\%$, RF RSD < 30%).

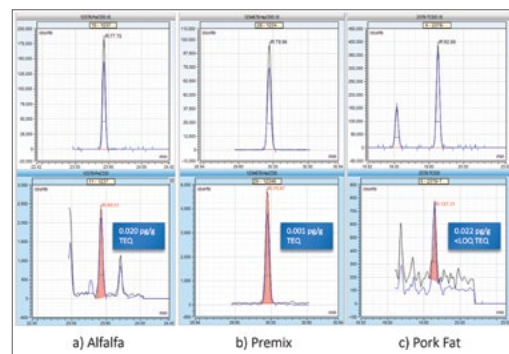

Selected peaks taken from Alfalfa, Premix and Pork Fat samples. The peak shown in the Pork Fat sample is below the LOQ and therefore the Upperbound TEQ is displayed.

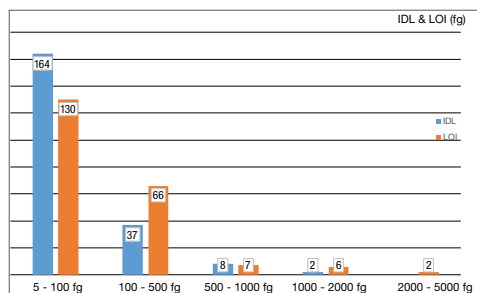

AEI source sensitivity for pesticides in baby food (carrot and potato based) (left) Instrument detection limit (IDL – Student's t, 99% confidence) and SANTE limit of identification (LOI) for 211 pesticide residues (annotated – number of pesticides at that level). 95% of pesticides measured were detected below 500fg using the AEI source. (right) SANTE compliant identification example, dichlobenil and chlorobenzilate at 25 fg on column level.

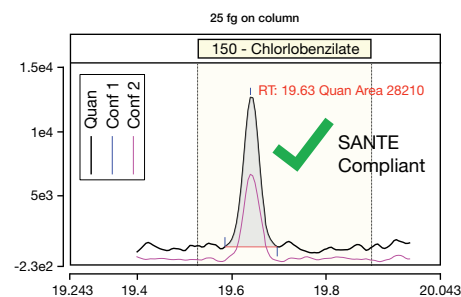
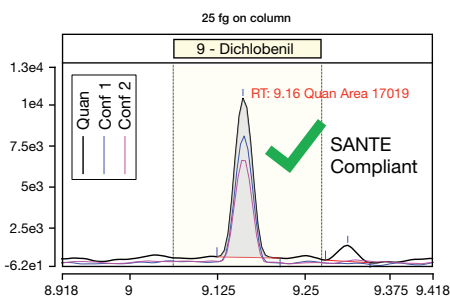

*IDL is a demonstration of maximum performance calculated using Student's t test at 99% confidence limits measuring only a single compound and not taking into account full confirmatory method criteria for regulated dioxin analysis

Unstoppable uptime

Maintaining uptime during routine analysis drives service delivery and lowers overhead costs. We understand this, and that is why we have designed the TSQ 9000 GC-MS/MS system to minimize maintenance intervals with routine-grade robustness, and to eliminate up to 98% of the downtime associated with routine maintenance of a system. Thermo Scientific™ NeverVent™ technology*, Instant Connect modularity, along with a high robustness design throughout ensures your instrument is still online and producing the highest quality results possible.

High robustness design

The TSQ 9000 GC-MS/MS system is designed specifically for complex sample matrices in high-throughput applications. Whether you select the ExtractaBrite or the AEI configuration, you will benefit from class-leading robustness to maximize uptime between routine maintenance interventions and ensure your system performs as you need it, when you need it.

The wireless ExtractaBrite ion source is heated throughout and includes the first RF region (RF lens), commonly the first place susceptible to ion burn. This design ensures high matrix tolerance for high throughput applications. The AEI source is also heated throughout, with RF lenses and benefits from an innate ultra-robustness due to a more tightly focused ion beam, limiting ion burn on the source lenses.

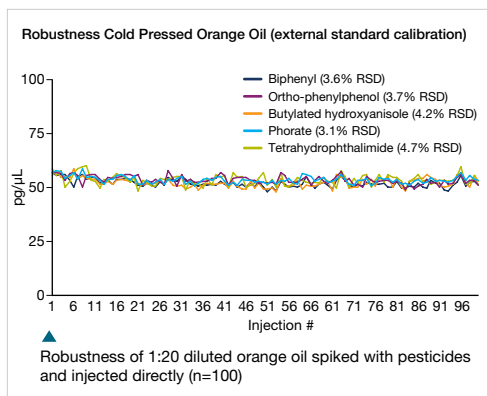

ExtractaBrite source robustness in heavy matrix: 1:20 diluted cold pressed orange oil injected directly onto system without clean-up (n=100)

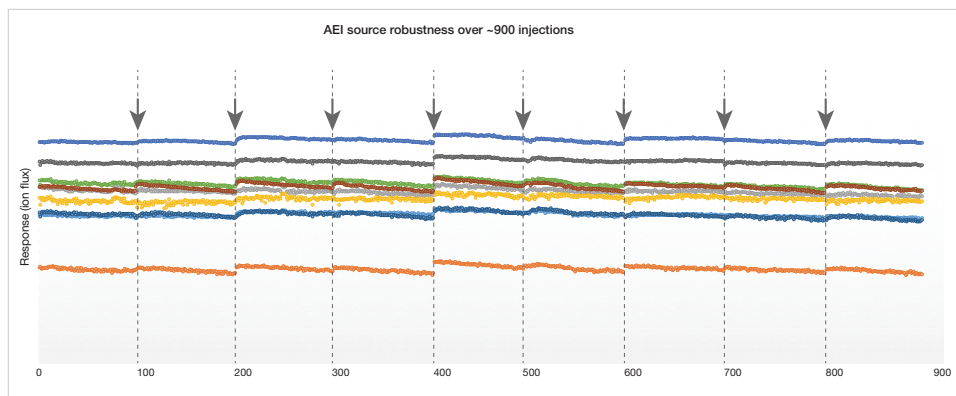

AEI source robustness data showing almost 900 sequential injections of matrix sample extract spiked with 150 pesticides at 10 ppb. >90% of the pesticides exhibited a Relative Standard Deviation of <20%. Injector maintenance and tuning intervals are marked with an arrow. No source cleaning was performed during the sequence.

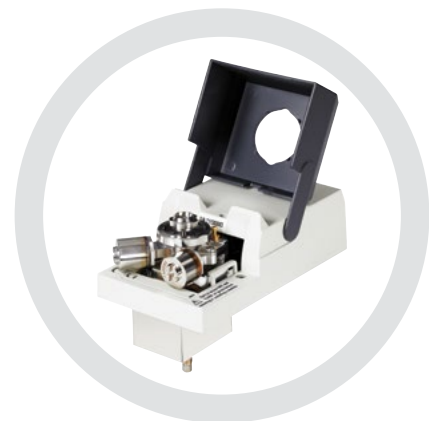

Step into modern gas chromatography

Tailor the Thermo Scientific™ TRACE™ 1300 Series Gas Chromatograph to your needs with its proprietary user-exchangeable Instant Connect injector and detector modules. Swapping modules is easy, removing and replacing just three screws, accessible from the top of the GC system. The entire process takes less than five minutes without requiring specialized service assistance. This modularity enables maximum uptime with offline cleaning and servicing of the GC inlet possible by adding a spare module to your configuration.

NeverVent Technology

The TSQ 9000 system takes your GC-MS/MS uptime to the next level with patented NeverVent technology*. Using the vacuum probe interlock (VPI) in conjunction with the ExtractaBrite source and the new V-Lock source plug, routine maintenance operations such as source cleaning and column changing can





be performed on the system without the need to vent the mass spectrometer. This boosts instrument productivity to unprecedented levels, meaning your time can be spent on producing quality results.

*Only available with Extractabrite configuration



ExtractaBrite Ion Source

Using the VPI, the ExtractaBrite ion source is fully removable (even when hot) under vacuum for necessary cleaning or swapping with a spare source. There is never a need to vent to clean your instrument or to heat or clean quadrupoles.

		Maintenance activity	
		Change column** (hrs: mins)	Exchange ion source (hrs: mins)
Standard GC-MS	Requires vacuum system venting and pump down operations	 4:35	 4:00
NeverVent	No venting and pump down of vacuum system required	 00:35	 00:05
NeverVent time savings		87%	98%

V-Lock

Exclusively available on VPI enabled systems, V-Lock isolates the vacuum region of the mass spectrometer from the GC column. This enables GC column changes to be performed quickly, with no venting required. There are no complicated fluidics with additional auxiliary gases or column unions that can potentially leak.

**Includes conditioning

Unstoppable ease of use

Don't let complexity stand in the way of unstoppable productivity. Truly powerful routine workflows have to be easy to stay productive and to deliver quality results on time, every time. It's this reason why the TSQ 9000 GC-MS/MS system includes a comprehensive set of simple tools to provide the user with a seamless experience during the transition from other platforms, analytical method development and routine analysis of samples.

Method Development

1

Column in file	Map to	Example
Name	RT	NDMA
RT	RT	4.343
Ion Polarity	Ion Polarity	Positive
Window	Window (min)	0.1
Pre-width	Pre-width (min)	0
Post-width	Post-width (min)	0
Mass	Mass	88.1
Product Mass	Product Mass	71.1
Collision Energy	Collision Energy	4
Product (1) Resolution	Product (1) Resolution	Normal
Product (2) Resolution	Product (2) Resolution	Normal

Name	RT	Window (min)	Ion Polarity	Mass	Product Mass	Collision Energy	Pre-width (min)	Post-width
2,4-Dichlorophenylbenzamide	10.183	0.1	Positive	140.1	120.1	14	0	0
Methacocis	10.244	0.1	Positive	207.9	180.1	6	0	0
Methacocis	10.244	0.1	Positive	129	79	8	0	0
Methacocis	10.244	0.1	Positive	124.9	47.1	12	0	0
Tetrahydrothialamide (THF)	10.264	0.1	Positive	151	79.9	6	0	0
Tetrahydrothialamide (THF)	10.264	0.1	Positive	151	77.1	32	0	0
Tetrahydrothialamide (THF)	10.264	0.1	Positive	151	122.1	8	0	0
Chloronab	10.354	0.1	Positive	190.9	193	14	0	0
Chloronab	10.354	0.1	Positive	193	53.1	32	0	0
Chloronab	10.354	0.1	Positive	193	115	14	0	0

2

Name	RT	Mass	Product Mass	Ion Polarity	Row File	tR Energy
Parent default	13.789	333.1	231.1	11	ParentDefault_AUTO_SIRM_1	20
Parent default	13.789	333.1	231.1	11	ParentDefault_AUTO_SIRM_1	20
Parent default	13.789	380.0	281.1	11	ParentDefault_AUTO_SIRM_1	20
Parent default	13.789	380.0	281.1	11	ParentDefault_AUTO_SIRM_1	20
Parent default	13.789	380.0	333.1	11	ParentDefault_AUTO_SIRM_2	10
Parent default	13.789	380.0	333.1	11	ParentDefault_AUTO_SIRM_2	10
Parent default	13.789	380.0	333.1	11	ParentDefault_AUTO_SIRM_2	10
Parent default	13.789	380.0	333.1	11	ParentDefault_AUTO_SIRM_2	10
Parent default	13.789	380.0	333.1	11	ParentDefault_AUTO_SIRM_2	10
Parent default	13.789	380.0	333.1	11	ParentDefault_AUTO_SIRM_2	10

3

Name	RT	Mass	Product Mass	CE
Parent default	13.789	333.1	231.1	20
Parent default	13.789	333.1	231.1	20
Parent default	13.789	380.0	281.1	20
Parent default	13.789	380.0	281.1	20
Parent default	13.789	380.0	333.1	12
Parent default	13.789	380.0	333.1	12
Parent default	13.789	380.0	333.1	12
Parent default	13.789	380.0	333.1	12
Parent default	13.789	380.0	333.1	12
Parent default	13.789	380.0	333.1	12

1 SIM Bridge

The SIM Bridge tool allows SIM methods exported from other sources to be translated to the TSQ 9000 system method. Those SIM methods can be immediately run on the TSQ 9000 system or through AutoSRM to translate the SIM information into a powerful SRM method.

2 AutoSRM

AutoSRM is your very own mass spectrometer method development expert integrated into your system. This software walks you through the development of fully optimized SIM target ions or SRM transitions in a very simple and efficient workflow. If you like to develop from your current SIM method, SIM Bridge streamlines the workflow by importing your method details. All together, it is full MS and MS/MS method development independence, even for the less experienced user.

3 Timed-SRM method

As more compounds are added to a single run, managing acquisition windows becomes increasingly complex. The TSQ 9000 system dramatically reduces this complexity by automatically optimizing the targeting of a particular compound. Simply enter the retention time and the time required to capture the peak, and t-SRM takes care of the rest. This ensures that compound detection is optimized for maximum sensitivity, and more compounds can be added to the method without compromising the excellent sensitivity of each individual analyte. The mass spectrometer is not consuming valuable resources scanning for compounds at the times when those compounds are not eluting.

Routine Analysis

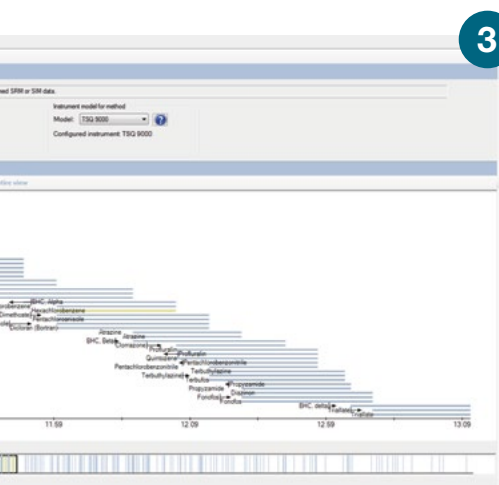

3

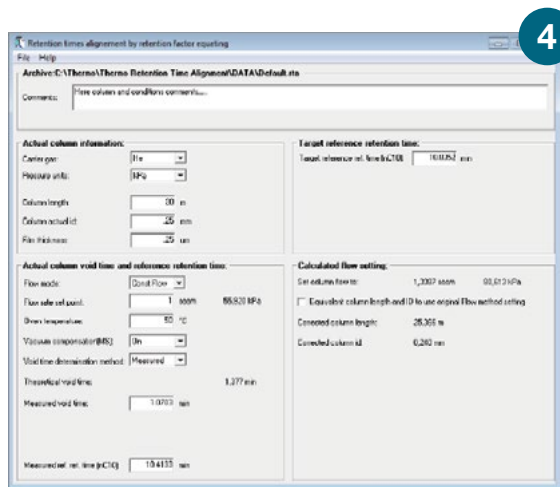

4



5

4 Retention Time Alignment (RTA)

The new RTA tool is a faster, more flexible and easier way to maintain retention times during routine operation of high-throughput GC-MS methods. The tool uses the measured void time of the column and the retention time of a reference substance to provide a new column length and internal diameter settings (or corrected pressure or flow value) to realign retention times of all the peaks of the chromatograms. This means that during a column change or trim, the user can quickly re-align their retention times and return to collecting results.

5 SmartTune

SmartTune is the new simplified tuning tool for Thermo Scientific ISQ and TSQ instruments. This intuitive tool removes tuning complexity and ensures your system is performing at the level you require, ahead of running your samples. A simple guided interface efficiently checks and tunes the system, and intelligently eliminates any unnecessary steps in the process, resulting in faster tuning operations. If a problem is detected, SmartTune advises you on recommended corrective action. In addition, SmartTune allows user customizable targets to facilitate consistency in performance between analytical sequences.

Unstoppable workflows

The constant pressure to increase productivity challenges laboratory staff at every level, from the technician to management. Streamlined, workflow-driven software solutions are needed to address these challenges. At the same time, the growing list of compounds that laboratories must quantify and screen, combined with increasingly complex regulatory requirements, necessitate flexible method development and powerful reporting tools.

Chromeleon CDS Software

Use Thermo Scientific™ Chromeleon™ Chromatography Data System (CDS) software to control your entire chromatography lab. It is fully scalable from a single workstation to an enterprise-wide installation, and provides control of more than 350 modules from Thermo Fisher

Scientific™ and many other vendors, including support for quantitative mass spectrometry workflows for all separation techniques and MS variants, all using the same intuitive user interface.

Integrated control of mass spectrometry instruments

- A single software to streamline your chromatography and MS quantitation workflows
- Full integration of Thermo Fisher Scientific MS instruments using native control drivers
- Powerful features bring unrivalled usability, scalability and compliance benefits to MS users
- Data processing per component using MS-specific detection algorithms
- MS-specific views including Total Ion Chromatogram (TIC), Extracted-ion Chromatogram (XIC), Mass Spectra, quantitation channel, and MS component traces
- AutoSIM/AutoSRM for automated SIM/SRM method development
- Use your MS like any other routine detector

Boost laboratory efficiency with operational simplicity and intelligent functionality

Chromeleon CDS was designed with scientists and technicians in mind. It simplifies repetitive tasks, reduces errors and helps you to achieve more 'right first time' analyses. These smart tools make your work faster and easier while ensuring reproducible, quality results.

- Reduce errors in sequence setup using Thermo Scientific™ eWorkflows™
- Achieve more "right first time" analyses using Intelligent Run Control
- Experience faster data processing, reviewing and reporting with dynamic updating and smart tools built in



Chromeleon XPS: Walk up and run

Thermo Scientific™ Chromeleon™ XPS Open Access software lets any untrained user run samples on their own using a streamlined walk-up interface while utilizing the full power of Chromeleon.



AppsLab Library: Jump start your method development

Find applications and download ready-to-use eWorkflows from the Thermo Scientific™ AppsLab Library of analytical applications right into Chromeleon CDS where they can be directly executed.

Learn more: appslab.thermofisher.com

Environmental analysis templates

The Environmental Analysis Extension Pack is a full set of predefined templates and methods that allows for running GC-MS environmental analysis to quickly and easily calculate results and generate reports in a manner consistent with the requirements of the United States (U.S.) Environmental Protection Agency (EPA).

No.	Name	Eval. Result	Operator	Ref. Value 1	Ref. Value 2	Result
1	m/z 51 - 10 to 80% of the base peak	43.5	between	10	80	Passed
2	m/z 68 - Less than 2% of m/z 69	0.5	<	2		Passed
3	m/z 70 - Less than 2% of m/z 69	0.4	<	2		Passed
4	m/z 127 - 10 to 80% of the base peak	31.1	between	10	80	Passed
5	m/z 197 - Less than 2% of m/z 198	0.1	<	2		Passed
6	m/z 198 - Greater than 50% of m/z 442	55.0	>	50		Passed
7	m/z 199 - 5 to 9% of m/z 198	5.7	between	5	9	Passed
8	m/z 275 - 10 to 60% of the base peak	11.9	between	10	60	Passed
9	m/z 365 - Greater than 1% of m/z 198	4.3	>	1		Passed
10	m/z 441 - Present	1433459.1	>	0		Passed
11	m/z 441 - Less than 24% of m/z 442	16.2	<	24		Passed
12	m/z 442 - Greater than 50% of m/z 198	181.9	>	50		Passed
13	m/z 443 - 15 to 24% of m/z 442	18.1	between	15	24	Passed
Overall Result:						Passed

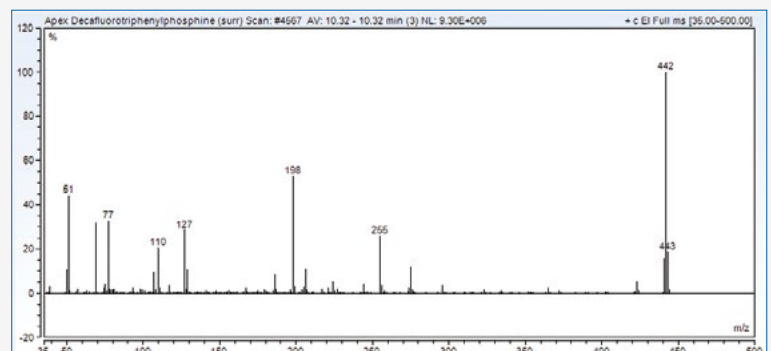

Automated DFTPP Tune check according to U.S. EPA guidelines



TraceFinder Software

TraceFinder software is the solution

Thermo Scientific™ TraceFinder™ software makes the challenging steps of targeted and untargeted analysis simple, fast and productive. It is the only software that can be used to develop methods, acquire and process data, and generate reports with the full portfolio of Thermo Scientific quantitative mass spectrometers. Tracefinder

software integrates the full range of popular front end chromatography systems, providing laboratories with the suite of features required to address their analytical demands. Now, regardless of the MS expertise of the user, the analytical requirements of every laboratory can be addressed with one software solution.

TraceFinder empowers you to tackle the everyday challenges in your laboratory

Challenge	TraceFinder
Maintain or increase laboratory productivity	One software for both HRAM and triple quadrupole MS platforms. Scientists now have the ability to leverage information from method development in early stage work to quickly enable data review in routine quantitative analysis.
Customizable reporting templates	Customized templates and automatic generation of reports save time and organizational resources.
Efficient method development regardless of expertise	Method development wizard, comprehensive database, and the ability to address critical parameters for all molecule types enable development of sensitive, robust, and reproducible quantitation methods.



Comprehensive data review allows for rapid data quality determination.

Unstoppable design

- 1 Optional **Vacuum Probe Interlock (VPI)** enabling NeverVent technology
- 2 **Dual source heaters** ensuring maximum robustness in heavy matrix
- 3 **S-shaped ion guide** for off-axis ion optics, eliminating neutral noise
- 4 Solid, homogeneous non-coated, non-heated maintenance-free quadrupoles

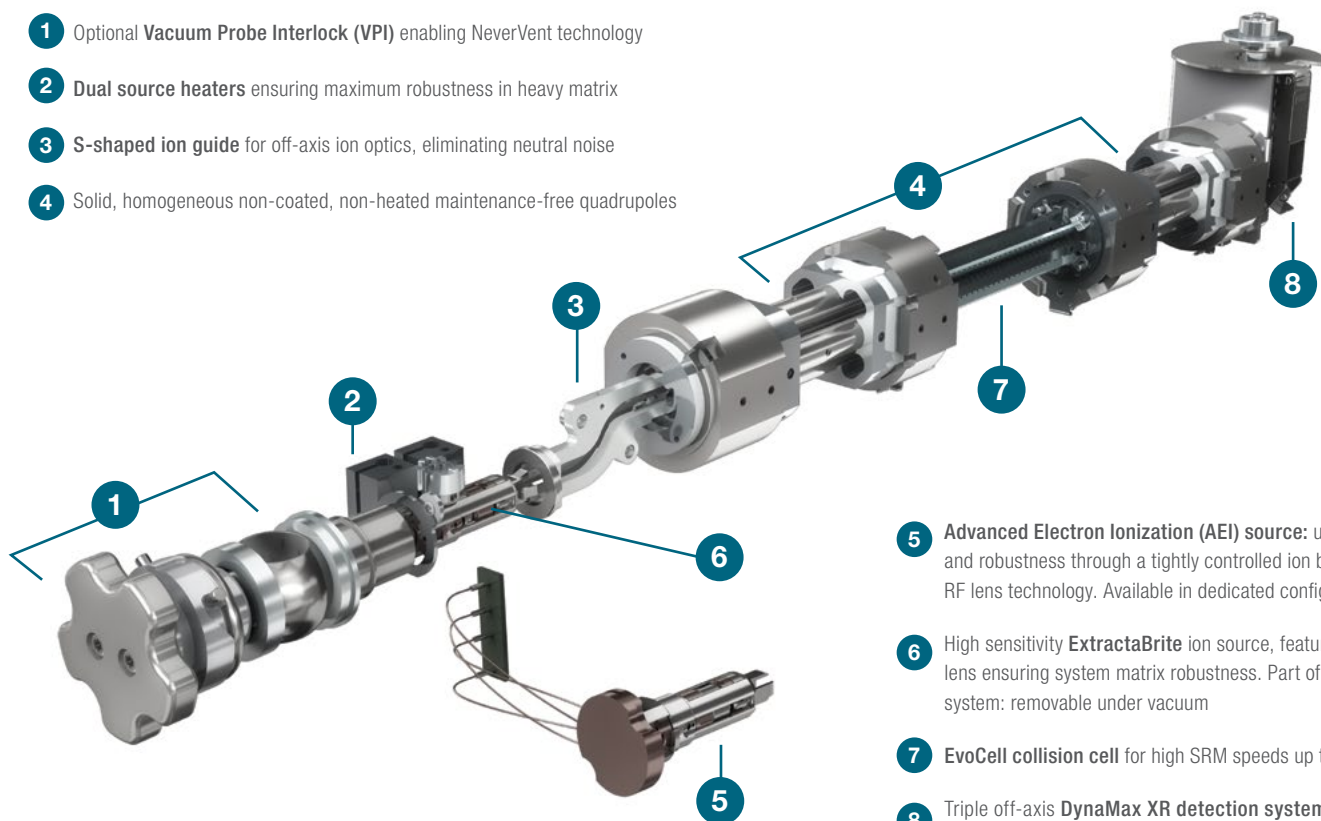

- 5 **Advanced Electron Ionization (AEI) source:** ultimate sensitivity and robustness through a tightly controlled ion beam. Featuring RF lens technology. Available in dedicated configuration
- 6 High sensitivity **ExtractaBrite** ion source, featuring patented RF lens ensuring system matrix robustness. Part of the NeverVent system: removable under vacuum
- 7 **EvoCell collision cell** for high SRM speeds up to 800 SRM/s
- 8 Triple off-axis **DynaMax XR detection system**, with off-axis 10 kV dynode, discrete dynode electron multiplier and electrometer with high linear range

ExtractaBrite ion sources and probes are removable without requiring a break in the vacuum, and they enable you to perform MS and MS/MS experiments on solids in real time while effortlessly switching between electron ionization (EI) and chemical ionization (CI).

Direct Insertion Probe (DIP)

Slower volatilization with heated capillary tube for solid samples. The DIP can be utilized for rapid analysis of solids or trace components in solid matrices such as forensic samples, tissue, etc.



Direct Exposure Probe (DEP)

Rapid heating filament for liquids or solutions. The DEP is ideal for rapid molecular weight confirmation of solids dissolved or suspended in a suitable solvent.



Chemical Ionization (CI)

Chemical ionization is a softer form of ionization than electron ionization (EI). It offers a greater opportunity to generate more abundant high mass and molecular ions and a higher degree of selectivity or sensitivity in the source ionization process, especially with negative chemical ionization (NCI), favoring electronegative compounds, such as halogenated species. Chemical ionization is ideally used for structure elucidation also in MS/MS mode.

Autosamplers

AI/AS 1310 Series Autosampler

Improve the consistency and quality of your gas chromatography (GC) results. Engineered to stand up to the demands of any busy high-throughput lab, the Thermo Scientific™ AI/AS 1310 Series Autosampler will help you process more samples more quickly and cost effectively with its advanced design and usability features.

- Pre- and post-injection syringe rinsing with single or combined solvents (A, B, C, D, A+B, C+D) virtually eliminates sample carry-over
- To ensure efficient, accurate sampling of low boiling compounds, the syringe is kept away from the inlet's temperature influence
- Two preset injection modes—Minimum and Standard Needle Depth—ensure optimum speed and performance both for cold needle and hot empty needle type injections

TriPlus RSH Autosampler: A step ahead in automated sampling

A perfect match for the TSQ 9000 GC-MS/MS system, the Thermo Scientific™ TriPlus™ RSH autosampler utilizes robotic sample handling to expand automated capabilities beyond liquid, headspace, and solid-phase micro extraction (SPME) injections to advanced sample handling cycles. Your results benefit from improved precision and reproducibility, while your laboratory gains unique advantages from the system's unattended operations and sample handling flexibility.

Automate basic sample and standards preparation procedures such as dilution, internal standard addition, and derivatization.

High precision injection from low volumes to maximize your analysis opportunities with your most precious samples.

Automated tool exchange to switch between different syringes and techniques “on-the-fly”.

Unstoppable scalability

In an evolving environment, it is difficult to clearly see what challenges lie ahead with your analysis.

In order to be ready for the future, choosing a flexible GC triple quadrupole system can make all the difference.

The TSQ 9000 GC-GC/MS system has been designed to allow a full upgrade path from base to advanced configurations, boosting flexibility and performance anytime you need it.



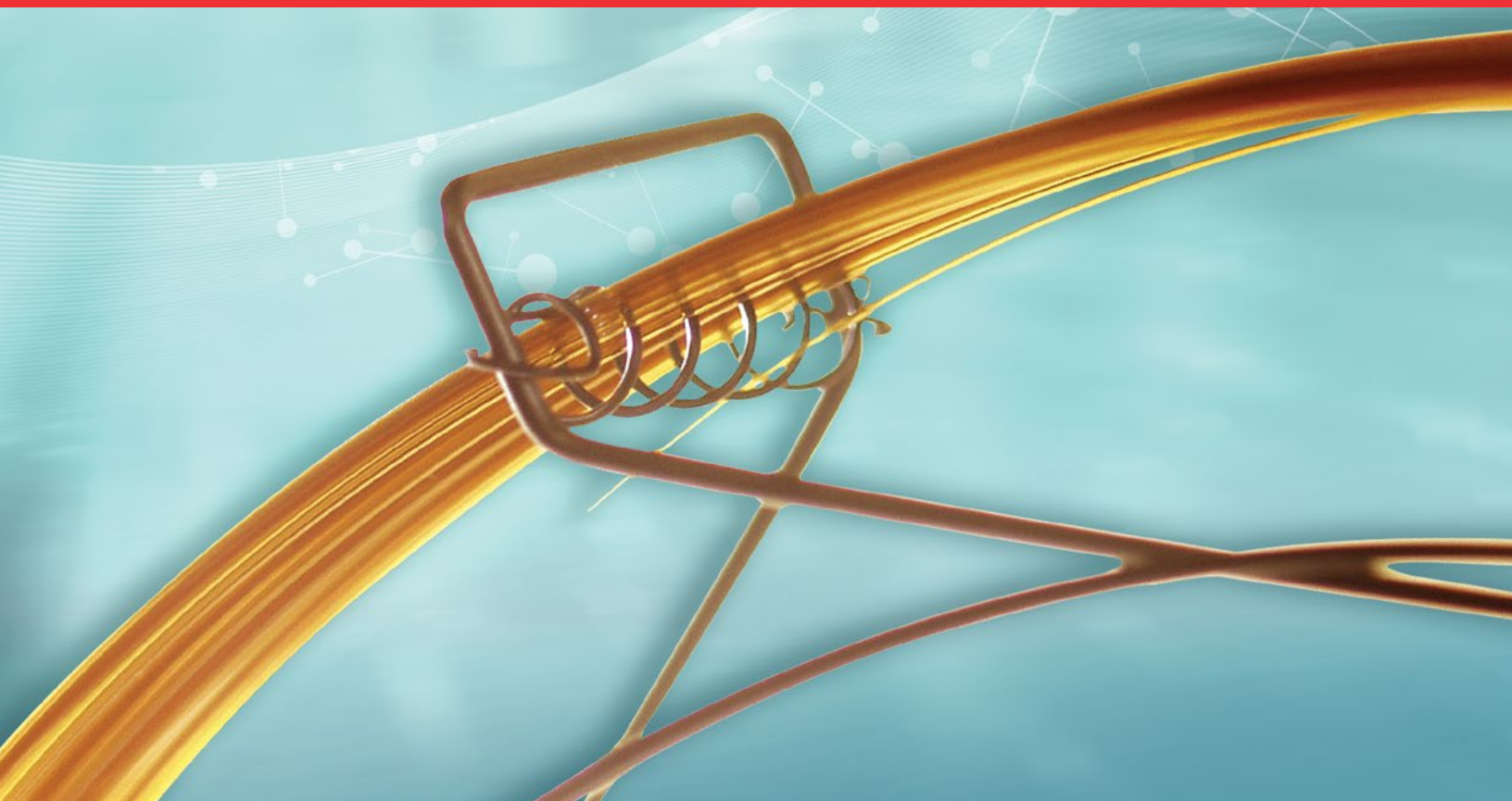

Thermo Scientific Chromatography Columns and Consumables

Get the most out of the TSQ 9000 GC-MS/MS system by pairing it with advanced, high-performance Thermo Scientific products. Our wide range of consumables and accessories offer customers applications-focused solutions in the environmental, food safety, toxicology, clinical, petrochemical, pharmaceutical and general analytical industries.

Learn more: thermofisher.com/chromexpert

- Thermo Scientific™ TraceGOLD™ Columns – low bleed, high reproducibility
- Consumables tested and certified on the Thermo Scientific™ TRACE™ 1300 Series GC systems
- Vials guaranteed for Thermo Scientific™ Autosampler systems
- Thermo Scientific™ GFM Pro Gas Flowmeter and Thermo Scientific™ GOLD Pro Gas Leak Detector for system installation and maintenance
- Derivatization reagents and Derivatization grade solvents

Find out more at thermofisher.com/TSQ9000

©2018 Thermo Fisher Scientific Inc. All rights reserved. All other trademarks are the property of Thermo Fisher Scientific and its subsidiaries. This information is presented as an example of the capabilities of Thermo Fisher Scientific products. It is not intended to encourage use of these products in any manners that might infringe the intellectual property rights of others. Specifications, terms and pricing are subject to change. Not all products are available in all countries. Please consult your local sales representative for details.

BR10587-EN 0218