

thermo scientific

Confident quantitation

For everyday excellence



Thermo Scientific TSQ Quantis
triple-stage quadrupole mass spectrometer

ThermoFisher
SCIENTIFIC

Experience confident quantitation: TSQ Quantis MS with **AIM+** Technology

Active collision cell with axial DC field

Enables ultra-fast selected reaction monitoring (SRM).

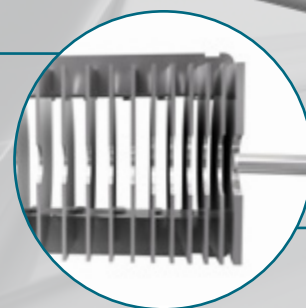
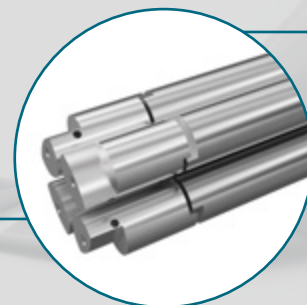
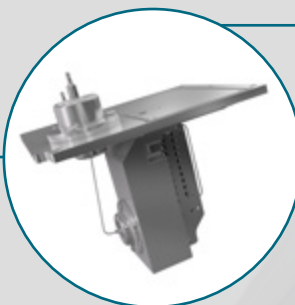
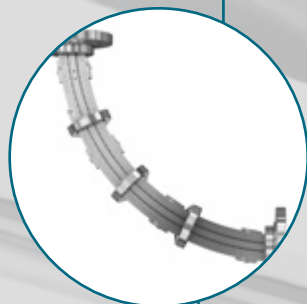

Ion transfer tube and Sweep cone

Provide maximum robustness and tool-free maintenance.

Stacked ring ion guide (RF lens)

Efficient ion introduction minimizing fragmentation and maximizing sensitivity.

Quantitative throughput with confidence

Your time is precious and you can't afford delays. You need a system that you can trust to deliver results day after day. The Thermo Scientific™ TSQ Quantis™ triple-stage quadrupole mass spectrometer enables robust, reliable quantitation with the sensitivity required to meet your workflow needs. Designed with ease-of-use in mind to ensure quality data from every user in every lab.

Sensitive, selective, fast

Advances to the ion source, mass analyzer and RF electronics result in the sensitivity, speed, reliability and consistency to confidently quantify compounds, day after day.

Robust, reliable, reproducible

The TSQ Quantis MS is designed for stable, reliable performance, and incorporates innovative approaches to increase robustness and reduce maintenance. Every TSQ Quantis MS will produce data that you can have confidence in.

Active Ion Management Plus (AIM+)

The next step in precision design delivers the ultimate in ion management, inception to detection, from the Thermo Scientific™ OptaMax™ NG ion source housing to the enhanced electron multiplier. AIM+ incorporates segmented quadrupoles and enhanced RF electronics to further optimize ion management precision, reliability, speed, and reproducibility.

Designed to ensure your confidence in results

To achieve your business and scientific goals, you need results you can count on. Regardless of your application, the TSQ Quantis triple-stage quadrupole mass spectrometer enables targeted quantitation workflows that ensure high quality results and confidence through innovative designs that provide exceptional reliability, consistency, robustness, and the sensitivity you need to meet your workflow needs.

Enhanced dual-mode discrete-dynode electron multiplier detector

Extends multiplier lifetime with increased surface area. Maintains excellent linearity and dynamic range.

QR4 Segmented Quadrupole mass filter with hyperbolic surfaces

Enhances ion transmission and consistency to ensure excellent sensitivity and reproducible results across instruments and over time for increased productivity.

Ion beam guide with neutral blocker

Provides robust performance and maximum sensitivity by blocking neutrals and efficiently transmitting ions.

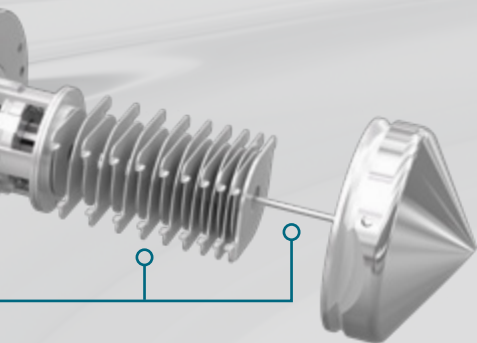

OptaMax NG ion source APCI ready

Automates all gas and voltage connections for ease-of-use. Provides optimizable spray position for ultimate performance in HESI or APCI mode.

Everyday usability for every user

The TSQ Quantis mass spectrometer provides practical ease-of-use and performance features to increase productivity.

- Simple maintenance (no need to break vacuum)
- More compounds per sample—more samples per day
- Automated compound optimization
- SRM visualization and optimization
- Streamlined data review and reporting

Automated Compound Optimization— User defined list of compounds optimized automatically

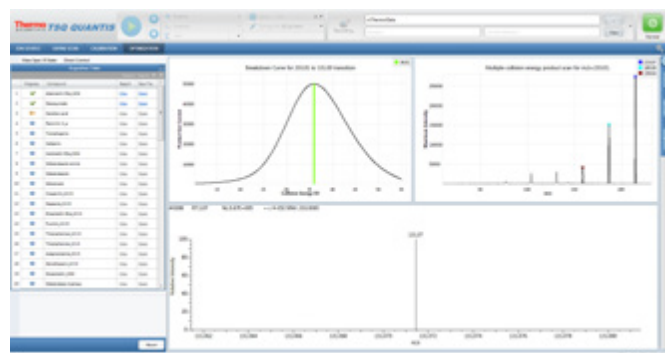

Keep up with regulatory limits in Environmental and Food Safety testing



The TSQ Quantis mass spectrometer enables environmental and food safety testing labs to address regulatory requirements with ease.

- Robust analysis of analytes in complex matrices with confidence

- Achieve desired productivity faster with automated compound optimization and application-specific methods and reports
- Outstanding speed enabling quantitation of hundreds of compounds simultaneously while meeting regulatory limits

Robust performance—maximize uptime

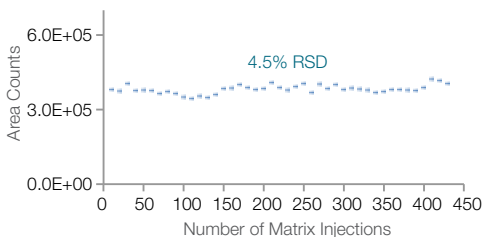

Atrazine in leek.
More than 400 injections over multiple days with consistent performance.

Increase productivity—monitor more compounds per unit time with excellent quantitative performance at low dwell times.

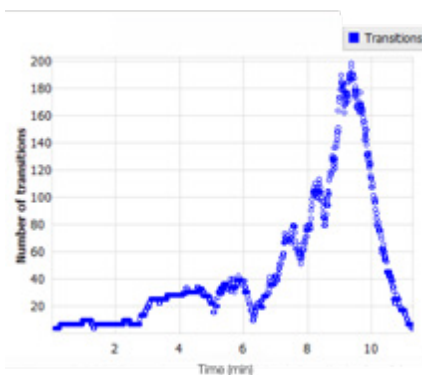

SRM visualization from Instrument Control Software 3.0 displaying the number of transitions per unit time.

Azoxystrobin in leek, 1ppb. Monitored at 2.5msec dwell time. AA: 465485

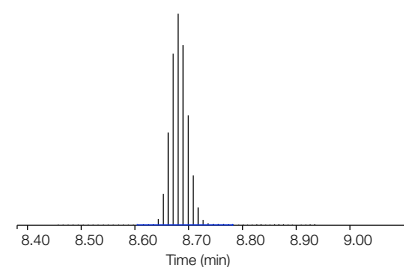

~160 transitions monitored simultaneously with polarity switching. Excellent reproducibility (%RSD 2.3) at 10X below the MRL.

Simplify your **Pharma** and **Biopharmaceutical** challenges

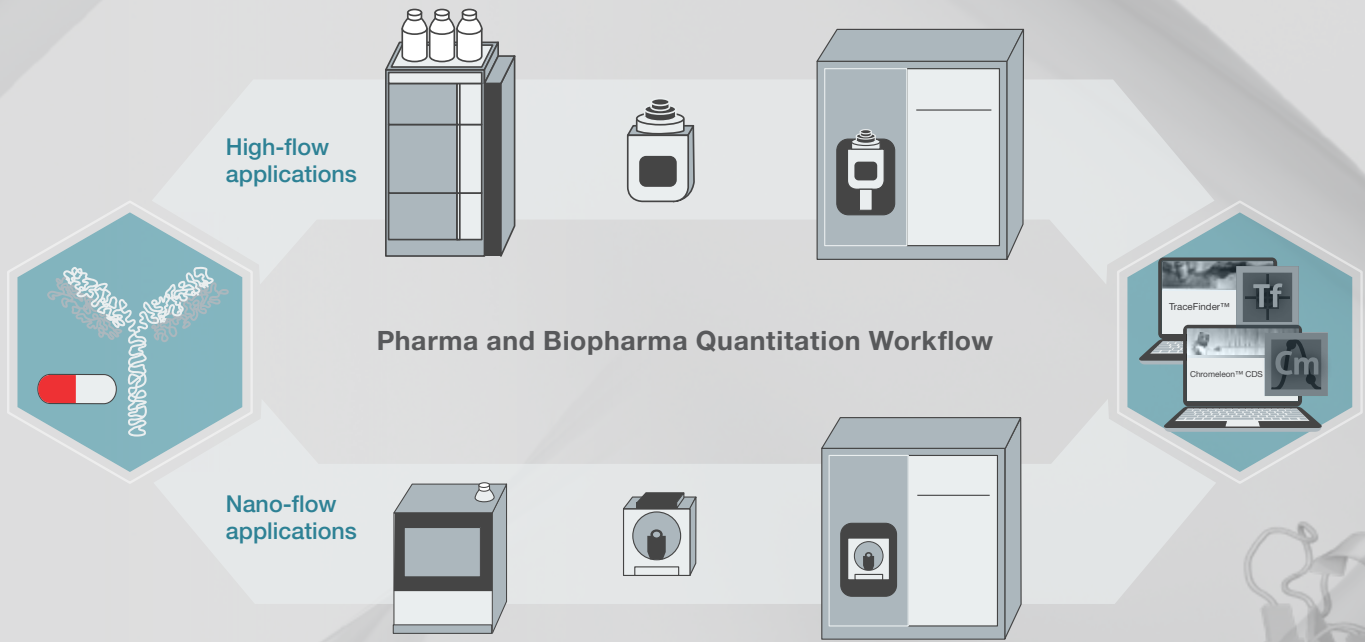

The usability, robustness and reliability of the TSQ Quantis mass spectrometer enable around-the-clock operation and maximize productivity in pharma and biopharmaceutical labs.

- Consistent, robust, and reliable performance for around-the-clock performance

- Ease-of-use that ensures quality data, regardless of user expertise
- Sensitivity and reproducibility to quantitate any molecule in complex biologic matrices

Consistent ion ratios for confident peptide quantitation

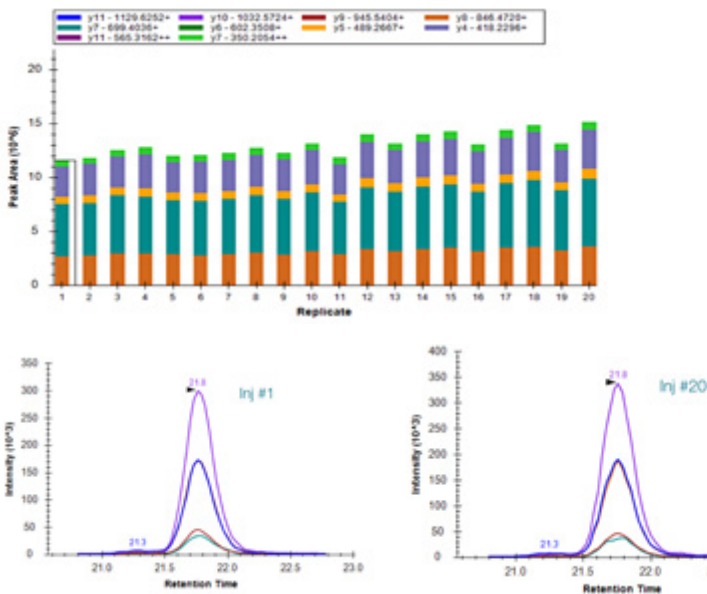

Excellent linearity and reproducibility across the dynamic range

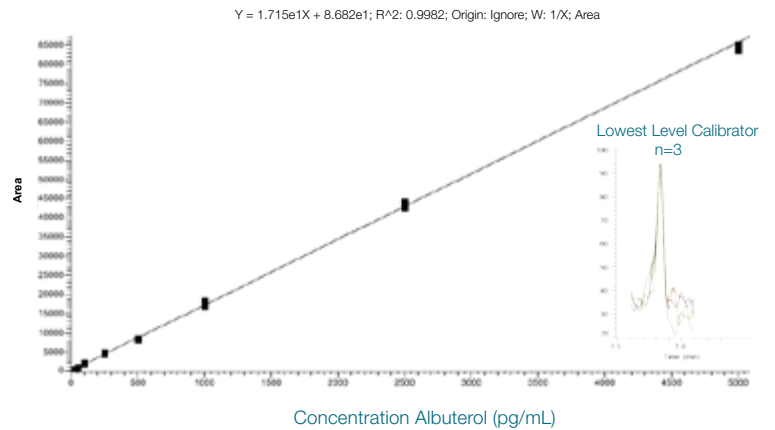

Obtain more confidence in **Clinical Research** and **Forensic Toxicology** results

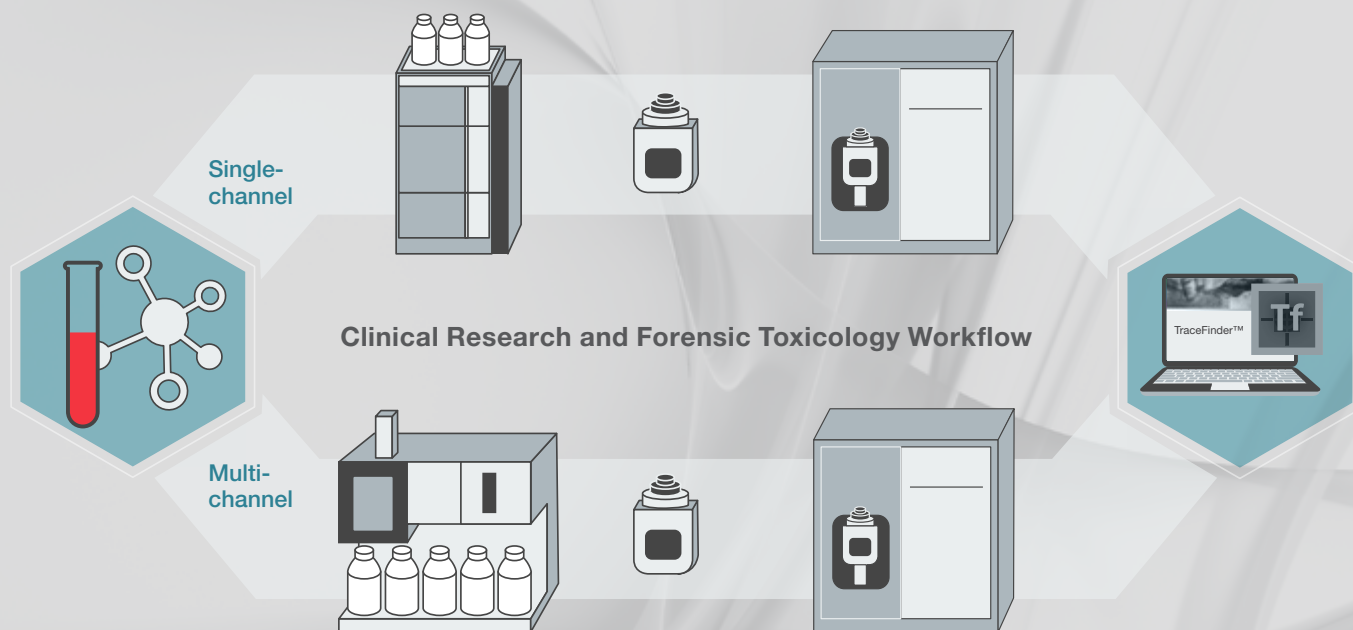

The TSQ Quantis mass spectrometer's reliability and sensitivity allow you to report results with confidence. Effortless method set up with industry leading multi-channel solutions and automated reporting enable robust high-throughput quantitation.

- Robust and consistent, able to run thousands of samples with no loss of performance
- Simple, tool-free routine maintenance
- Sensitivity and reproducibility make challenging assays easy

Excellent precision for the most challenging quantitative assays.

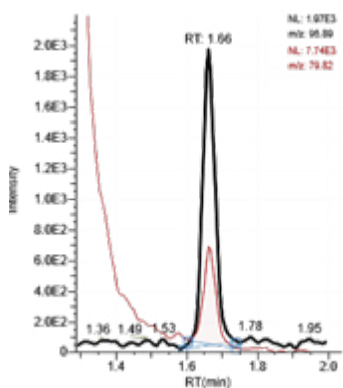

50 pg on column for Ethyl Sulfate

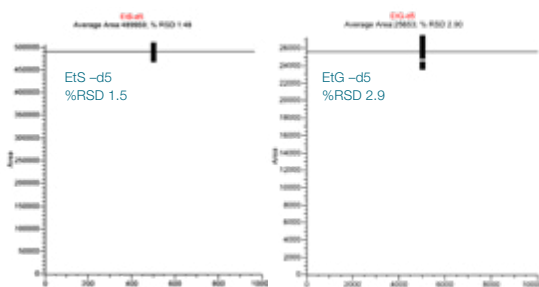

Robust and consistent performance under challenging conditions

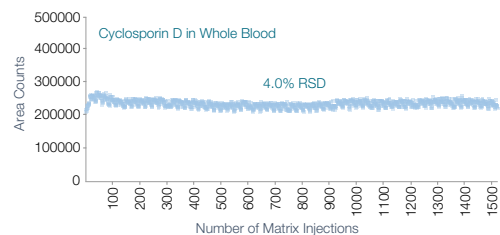

More than 1,500 injections with consistent performance.

Companion solutions for the TSQ Quantis mass spectrometer

Workflow-driven software, solutions, and support streamline your applications

Integrated workflow-driven software and solutions streamline everyday tasks from instrument optimization and troubleshooting to routine method development and results reporting.



Thermo Scientific™ TraceFinder™ software

Comprehensive quantitative workflows for all applications— from method development to report generation



AppsLab method library

A comprehensive repository for application methods, data sets, and application notes



Thermo Scientific™ Chromeleon™ software

Offers enterprise instrument control, data processing, and ability to address regulatory requirements

Our global Centers of Excellence, in-your-lab training using your methods, and AppsLab Library of Analytical Applications, ensure your success.

Chromatography solutions for MS

The TSQ Quantis mass spectrometer can be paired with a range of high-performance Thermo Scientific™ inlet systems.

- Thermo Scientific™ Vanquish™ UHPLC system
- Thermo Scientific™ Vanquish™ Flex, Horizon and Duo UHPLC systems
- Thermo Scientific™ Transcend™ II system
- Thermo Scientific™ Prelude SPLC™ system with multiplexing
- Thermo Scientific™ Dionex™ ICS-6000 Capillary HPIC™ system
- Thermo Scientific™ Dionex™ Integrion™ HPIC™ system

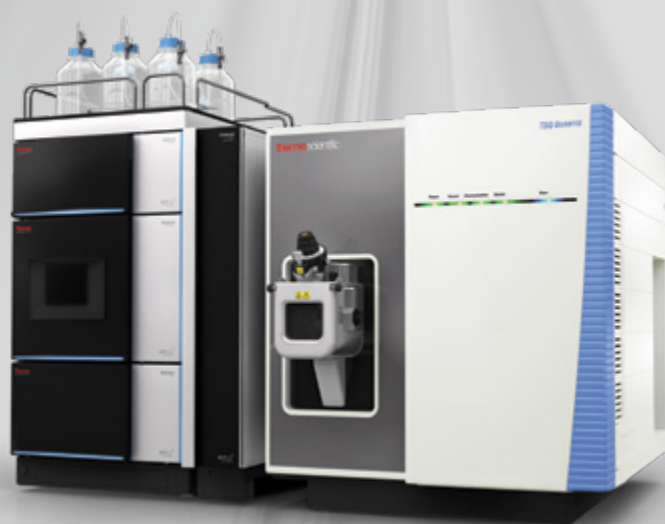

Transforming triple quadrupole mass spectrometers

The TSO Quantis mass spectrometer is one in a family of latest-generation Thermo Scientific™ triple quadrupole mass spectrometers that offer confident quantitation every day, for every lab and every user.

These instruments are built on a foundation of shared, state-of-the-art hardware and software components. This makes it easier to transfer methods from one instrument to another when methods progress from single, sample-based experiments to validation and routine high-volume screening and quantitation.



Almanac web-based monitoring and management

The ability to remotely access and manage your LC-MS and GC-MS systems lets you focus on other important tasks during your day. Using the Almanac phone App, Instrument Connect or web-based application, you can check real-time system status and acquisition, set up automated e-mails to notify you of a completed acquisition or error, schedule instrument access, monitor utilization, or submit information to service personnel to aid in instrument diagnostics. thermofisher.com/almanac



Technical and online support: peak performance for your instruments

Helping you keep your instruments running at peak performance is our goal. Whether you're looking for an instrument manual or spare parts, want to submit a repair request, or check on the status of your warranty or service contract, we have every support option you're looking for. thermofisher.com/technicalresources



Protecting your investments: unparalleled laboratory services

Unity™ Lab Services provides a single source for integrated lab service, support, and supply management. Our customized service offerings and world-class service experts have the flexibility and experience to effectively address your laboratory's business needs. We provide a complete portfolio of services and support solutions designed to help you improve productivity, reduce total cost of ownership, and ensure performance throughout your laboratory—from instrument and equipment acquisition to disposition. unitylabservices.com

Find out more at thermofisher.com/Quantis

ThermoFisher
SCIENTIFIC